

**Appendix C: Two Possible Designs for Animal Contact Facilities,
with Separate Animal and Non-animal/Food Areas as well as Transition Areas**

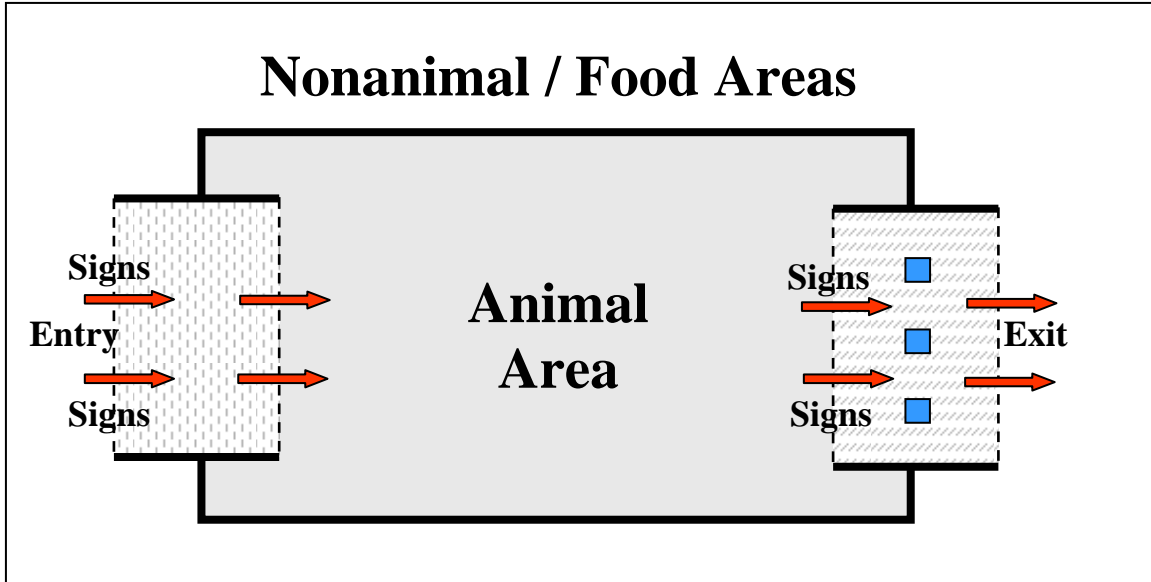

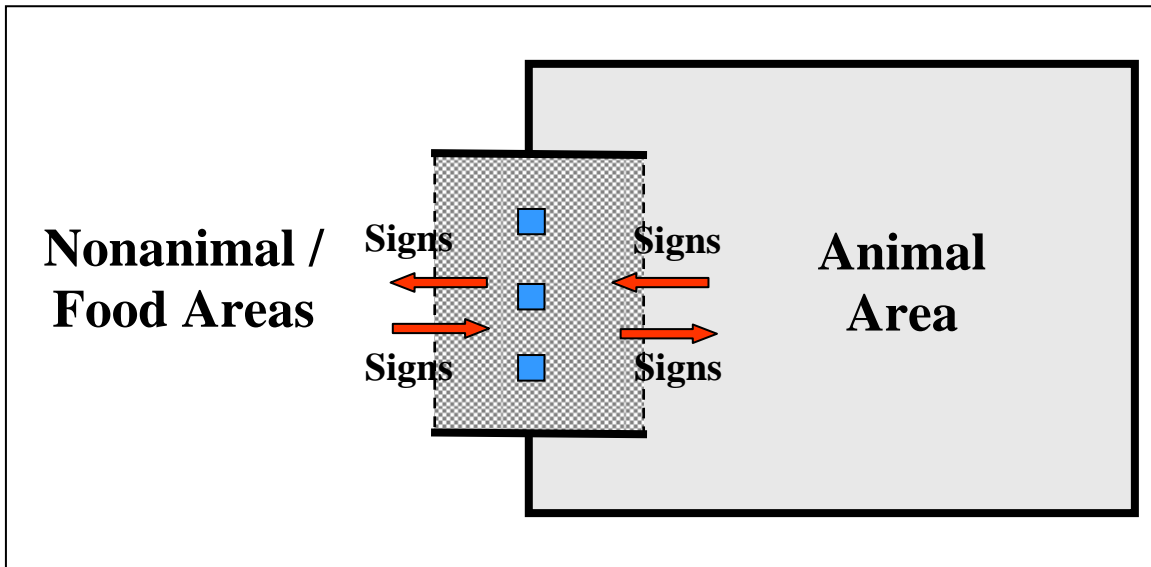

Design 1



Design 2



Legend

-  Transition into animal area  Transition out of animal area
-  Transition into and out of animal area (single entry and exit, Design 2)
-  Flow of visitors  Hand-washing station
- 