



# Public Pool Renovation Plan Approval Requirements

**DEC 2024**

Los Angeles County  
Department of Public Health  
Environmental Health Division  
Recreational Waters Program



# TABLE OF CONTENTS

INTRODUCTION	3
FLOW CHART	4
GENERAL INFORMATION AND REQUIREMENTS	5
PLAN SUBMISSION & PAYMENT INSTRUCTIONS	5
PLAN SUBMISSION REQUIREMENTS	6
<b>DECK REPLACEMENT</b>	6
<b>RESURFACE</b>	6
<b>EQUIPMENT CHANGE OR PLUMBING</b>	6
<b>CHANGE TO ENCLOSURE</b>	7
<b>CHANGES OR ADDITION OF RESTROOMS</b>	7
<b>SOLAR SYSTEM</b>	7
GENERAL PUBLIC POOL REQUIREMENTS; CHANGE OR REMODELING	7
<b>Required at All Times</b>	7
<b>Required When the Deck is Replaced</b>	9
<b>Required When the Pool is Drained</b>	9
<b>Required When the Pool Coping is Replaced</b>	10
<b>Required When the Pool is Resurfaced</b>	10
<b>Required When the Pool Equipment is Changed, or Pool is Replumbed</b>	10
<b>Required When the Pool Enclosure is Altered or Replaced</b>	11
<b>Required When Restrooms are Added or Changed</b>	12
<b>Required When a Solar System is Added or Changed</b>	12
CONSTRUCTION INSPECTIONS	13
APPENDICES	14
<b>Figures and Tables</b>	14
1. Coping	14
2. Fencing Dimensions	15
3. Stair and Handrail Dimensions	16
<b>Checklist</b>	17

## INTRODUCTION

Public pools, including swimming pools, spas, spray grounds, wading pools, and special purpose pools located at apartments, condominiums, gated communities, hotels and motels, public and private schools, health clubs, city and county parks, mobile home parks, resorts and organizations, medical facilities, and water theme parks are under the responsibility of the Los Angeles County Department of Public Health's Recreational Waters Program for plan review and approval. Public pools do not include individual therapeutic tubs or baths for cleaning the body that are drained and filled after each use, or pools at private single-family homes or dwellings with three units or fewer. This document contains basic requirements of the California pool code as well as requirements for submitting plans for a public pool in Los Angeles County.

### **Why are plans required?**

It is important for public health and safety that pools and their ancillary facilities that are being constructed or renovated are properly constructed. Plan reviews and approvals are a cost-effective way to ensure that public pools meet the applicable code requirements and are safe. The California Health and Safety Code, Title 22 of the California Code of Regulations, and Title 24, the California Building Code, provide the legal authority and requirements for the construction and operation of public pools.

### **When will the plans be reviewed?**

It is the goal of the Recreational Waters Program to provide effective and efficient service by completing the initial plan review of all plans within 20 business days.

### **Where can I get information?**

The Recreational Waters website has information, forms, and the fee schedule.

<http://www.publichealth.lacounty.gov/eh/inspection/pool-plan-check.htm>

You may also call our main office at (626) 430-5360.

### **Where can plans be submitted?**

Effective February 1, 2023, the Division of Environmental Health is accepting electronic plan submittals in addition to the traditional paper plan submission. Plans are submitted to the Recreational Waters Program at the Environmental Health Headquarters:

Los Angeles County Department of Public Health  
Environmental Health, Recreational Waters Program  
5050 Commerce Dr.  
Baldwin Park, CA 91706  
(626) 430-5360

# Flow Chart

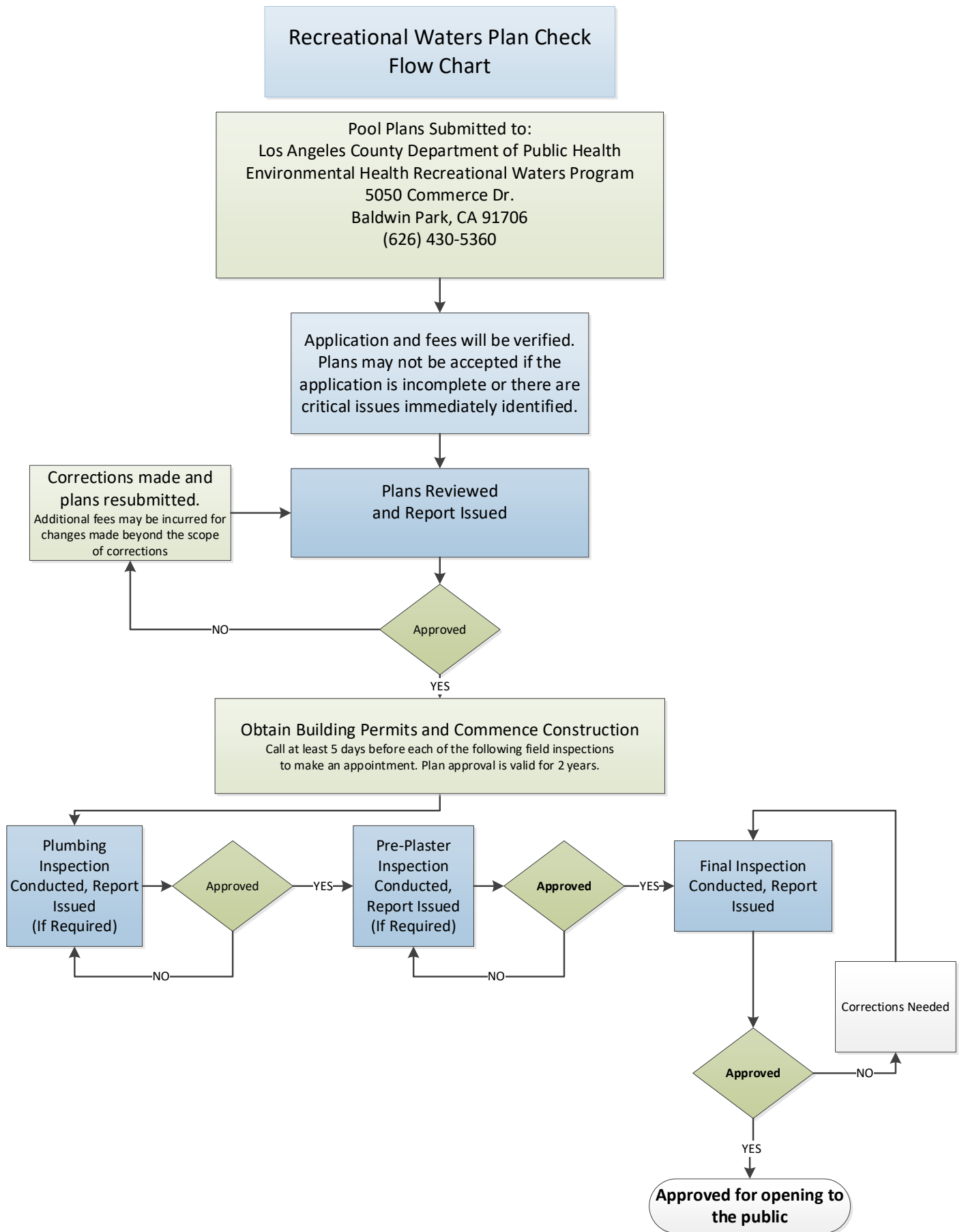

## GENERAL INFORMATION AND REQUIREMENTS

Any person proposing to renovate, alter, relocate, construct, reconstruct, or replace a public pool or change its ancillary facilities, mechanical equipment or related piping, is required to submit legible plans and specifications to the County of Los Angeles, Department of Public Health, Recreational Waters. Any time a dimension of a pool is changed it is considered a new pool. For new pool plan submittals, see the New Public Pool Plan Approval Requirements. Plan submittal is required for review and written approval prior to commencing the work and in advance of the issuance of any building, plumbing, or electrical permits.

Contractors must hold a valid California State Contractors License and work within the requirements of their classification as follows:

**C53 Pool Contractor, or an 'A' Engineering Contractor:** Licensed to build, replace, renovate, repair, and modify any pool.

**C61/D35:** Licensed to replace equipment and make repairs, including electrical, above ground plumbing, diving boards, and existing solar systems. Cannot resurface the pool, repair or replace underground plumbing, skimmers, or perform other work not listed above.

**C61/D35 and C36:** Licensed to perform the work of a C61/D35 contractor plus underground plumbing.

**C61/D35 and C35:** Licensed to perform the work of a C61/D35 contractor plus plastering.

**C46:** Licensed to perform solar system installation, modifications, and repairs.

A minimum of two complete sets of plans are required. One copy of the approved plans and specifications will be retained by the Recreational Waters Program. Plans and specification sheets should include all items listed in the plan submission requirements below.

The appropriate fee, paid to the County of Los Angeles, is required at the time of submission.

PLAN SUBMISSION AND PAYMENT		
<p>The Review/ Service Request, plans, supporting documents, and payment can be submitted in person, by mail, or electronically.</p> <ul style="list-style-type: none"> <li>• If plans are submitting online, an invoice will be generated and emailed to you along with payment instructions.</li> <li>• <b>Do not submit your payment until you have received an invoice.</b></li> <li>• Include your invoice number if paying by mail.</li> </ul>		
<p><b>IN-PERSON:</b> Submit plans and payment in person between the hours of 8:00 am - 4:30 pm, Monday through Friday, except for holidays, at:</p> <p><b>Environmental Health Headquarters 5050 Commerce Drive, Baldwin Park, CA 91706</b></p> <p>Acceptable forms of in-person payment include electronic, cash, check, cashier's check, or money order in the exact amount due.</p>	<p><b>ELECTRONICALLY:</b> Submit plans and payment online using Credit Card (Visa, MasterCard, American Express, or Discover), Debit Card, and Electronic Check (ECheck).</p> <p>Email to <a href="mailto:rhealth@ph.lacounty.gov">rhealth@ph.lacounty.gov</a> retrieve a secured email.</p> <p><b>Please note that there is an additional convenience fee charge using online payment.</b></p>	<p><b>MAIL:</b> Mail plans to the address below. An invoice will be generated and emailed to you along with payment instructions. Make Check, Cashier's Check, or Money Order payable to <b>County of Los Angeles</b>, and include your invoice number.</p> <p><b>Mail to: Environmental Health Headquarters 5050 Commerce Drive, Baldwin Park, CA 91706</b></p>

All equipment, materials, methods of construction, and design must be approved. All equipment must be installed per the manufacturer's instructions.

Any changes in plans or equipment must be approved by the Recreational Waters Program. Changes may require additional plan check fees and resubmittal of plans.

Pool plan approval does not authorize the violation of any law, ordinance, or regulation and final approval is subject to field inspection and evaluation. Written approval is required to open the pool for use.

Plan approvals are valid for a period of two years from the date of the stamp.

## PLAN SUBMISSION REQUIREMENTS

The following items are required to be included with the plan submission. Missing items may delay plan approval. See the requirements below and in the checklist in the Appendices.

1. A completed Service Request Application with the following information. The application form is available on the website and at our office.
  - A. Job Address - street number, city, zip code
  - B. Name, mailing address, email address, and telephone numbers of pool contractor and owner.
2. Required fee payable to the County of Los Angeles. See separate fee schedule.
3. Two sets of drawings. Drawings must include the job address and be drawn in a scale as appropriate for the project:
  - A. **DECK REPLACEMENT** - If the pool deck is being replaced, provide:
    - i. A simple top view drawing showing the length and width of the pool and scope of the deck replacement. If the enclosure is altered, see Change to Enclosure requirements.
    - ii. Surface material description. If other than concrete, a sample is required.
    - iii. Depth Marker and No Dive Symbol locations.
  - B. **RESURFACE** - If the pool is being resurfaced, provide:
    - i. A simple top view drawing showing the length and width of the pool.
    - ii. Resurfacing material and color (i.e., white plaster).
    - iii. Depth Marker depths and locations.
    - iv. Waterline tile (Contrasting, glossy smooth, easily cleanable)
    - v. Show the location of the contrasting tile on the floor at the 4 ½ ft. water depth. (Pools with a maximum water depth of 5 feet or less do not require a tile line).
    - vi. Ladder(s) at the deep end of the pool. (Pools with a maximum water depth of 4½ ft. or less are not required to have a ladder)
    - vii. Show the handrail(s) over the stairs with the distance from each step tread and deck to the top of the handrail.
    - viii. Coping detail if the pool coping is being replaced.
    - ix. If there is an existing diving board, provide scaled top and side view dimensions of the pool and diving board.
  - C. **EQUIPMENT CHANGE OR PLUMBING** – If any equipment is being changed, provide:
    - i. Year the pool was built.
    - ii. Volume of the pool.
    - iii. Make and model number of existing equipment and any new equipment that is being installed.
    - iv. Make and model of existing pump or new pump.
    - v. Size of suction and return lines going and coming from the equipment room.
    - vi. Make and model of drain covers.
    - vii. Plumbing material (PVC Schedule 40, copper etc.)
    - viii. Any other information that pertains to the equipment installation.
  - D. **CHANGE TO ENCLOSURE** – If the enclosure is altered in any way:
    - i. Show the pool with the proposed fence or building wall surrounding it.
    - ii. Show a scaled profile view of all fences, gates, and doors. Include latch hardware details. Must be self-closing and self-latching.
    - iii. Outline the entire enclosure with a yellow marker.
    - iv. Identify all areas outside of the enclosure to ensure they are public areas and not private areas or a property line(s).



- E. **CHANGES OR ADDITION OF RESTROOMS** – If the restrooms are altered or are added, the following are required:
- i. Plot plan to scale or showing distance to the restrooms from the pool wall.
  - ii. Total of pool(s) surface area.
  - iii. Show separate restrooms for men and women. Urinal(s) required in men's restroom.
  - iv. Indicate smooth, moisture resistant wall finishes throughout.
  - v. Floors must be concrete or similarly resilient surface extending upwards onto the walls at least 5" with an integrally coved junction and must slope,  $\frac{1}{4}$ " per foot (2%), to floor drain(s).
  - vi. Show shower(s) with adequate drainage and hot (not > 110°F) and cold water.
  - vii. Hand lavatory with hot and cold water, a single-service towel dispenser, and a permanently mounted soap dispenser.
  - viii. Show toilets(s) and urinal(s).
  - ix. Show drinking fountain(s).
  - x. Show separate locker/dressing facilities for all non-residential pool facilities.
- F. **SOLAR POWER** – If there are changes or an addition of Solar Power:
- i. The same items as #6 Equipment Change or Plumbing above are required.
  - ii. Provide panel and component information and documentation regarding NSF Standard 50 approval.
  - iii. Clearly indicate split suction is provided in the deepest portion of the pool, on the floor or within 3 inches of the floor and that the outlet is no closer than 5 feet from any inlet.

## GENERAL PUBLIC POOL REQUIREMENTS; CHANGE or REMODELING

When a change is made to a pool or its ancillary facilities, certain items are required to be upgraded, depending on what changes are being made to the pool. The headings describe when the requirement is necessary.

### Required at All Times

1. Equipment including pumps, filters, chemical feeders, skimmers, and other supplemental equipment shall comply with the applicable requirements established by the NSF/ANSI 50-2012 performance standard.
2. Each pool must be provided with separate recirculation, equipment, and treatment systems.
3. An influent pressure gauge placed before the filter but after the pump (usually found on top of the filter).
4. A flowmeter must be installed on a horizontal straight run of pipe with a minimum of 10 pipe diameters before and 4 pipe diameters after the flowmeter. It should be positioned after the filter and before the heater. It may be installed after the heater, if a great enough distance can be maintained so that heated water will not damage the flowmeter.
5. The direction of flow for the recirculation equipment shall be labeled clearly with directional symbols such as arrows on all piping in the equipment area. Where the recirculation equipment for more than one pool is located on site, the equipment shall be marked as to which pool the system serves. Valves and plumbing lines shall be labeled clearly with the source or destination descriptions.
6. No direct connection of a pool or its recirculating system shall be permitted with a sanitary sewer, storm drain, or deck drain system. A sight glass is required when needed for observation of backwash water.
7. Diatomaceous earth or similar media filters must be permanently plumbed to a p-trap with a fixed air gap and have a separation tank. Sand filters must be permanently plumbed to a p-trap with a fixed air gap. A sight glass is required for observation of backwash water. Cartridge filters must have a designated area with a hose bibb, and floor drain to clean the filter. An extra cartridge filter (element set) is required to be available at the pool site.

8. Each hose bibb at the site must be protected by an approved backflow device.
9. An automatic disinfectant feeding system is required. Chlorinators are required to supply not less than the equivalent of 3 pounds of chlorine per day per 10,000 gallons of pool water capacity. For pools constructed after September 2012, a chemical controller is required to monitor and control the pH and disinfectant levels. For pools constructed prior to September 2012, chlorinators are required to supply not less than the equivalent of 2 pounds of chlorine per day per 10,000 gallons of pool water capacity.
10. Chemical feeder pumps and recirculation system pumps are required to be electrically interconnected so that when the recirculation pump is off, chemical pumps are off.
11. All pools with diving boards will be evaluated during any plan check to assure it meets current pool code requirements.
12. Supplemental heat transfer systems for pools or spas must not interfere with the proper functioning of the recirculation system or reduce the filtration rate below the required minimum. Heat exchangers must be installed according to requirements in the California plumbing code.
13. An underwater light is required in a swimming pool or spa. All pool lights must be protected by a Ground Fault Circuit Interrupter. The light must be white (no color) and at least 0.5 watts per square foot of pool or spa surface area. If a lighting type other than incandescent lighting is used, such as fiber optic, fluorescent, halogen, or LED, their equivalency to incandescent lighting must be demonstrated.
14. An approved enclosure is required. See enclosure requirements and exceptions below.
15. Floating type pool covers are limited to pools where there is constant supervision with a responsible person opening the pool and removing the cover and closing the pool each day. Floating type pool covers, permanently installed, and safety type pool covers must be submitted to this Department for approval, be ANSI approved, must not obstruct the deck in any way, and must not interfere with the coping requirements. Pool covers must be approved by this Department prior to use.
16. A life ring with rope attached is required (spas and wading pools exempt). The rope must be as long as the maximum width of the pool (spas, wading pools exempt).
17. All pools are already required to be in compliance with Title 24, Section 3162 of the California Building Code (Virginia Graeme Baker Safety Act).

All suction drains on public pools must be split or have a safety vacuum release system or automatic pump shut-off system. All drain covers must be correctly sized and listed on the Los Angeles County Approved Equipment List. For details, refer to requirements for a new pool or a copy of the latest pool code. This is an immediate requirement.

If splitting drains, each pump located on any type of pool must be plumbed with at least two suction outlets. Suction outlets must be separated by a distance of at least 3 feet, measured from the center of one suction pipe to the other. The suction drains must be plumbed with a "T" in the center that is hydraulically balanced. Each branch of the "T" must be the same size or larger than the main suction plumbing.

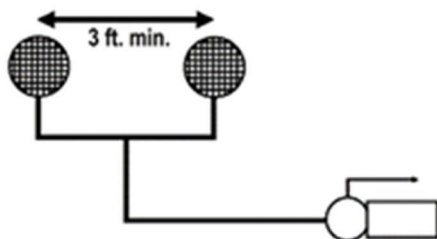

**Two Outlets**

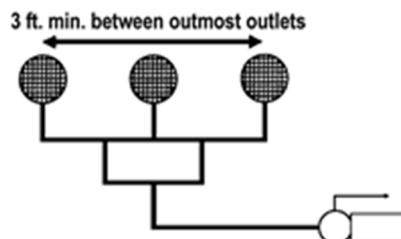

**Three Outlets**



## Required When the Deck is Replaced

1. A minimum 4 feet wide, continuous, slip-resistant, non-abrasive deck area of concrete or concrete like material must be provided flush with the top of the pool and extend completely around the pool and at least fifty percent around a spa pool. Deck material must be approved by this Department. Wood decking, plastic composite, foam rubber, or indoor-outdoor carpeting is **not** permitted. Deck measurements are made from the coping edge. The required decking around a pool must be free of all posts, columns, or other obstructions and extend at least 4 feet behind any diving board, slide, or permanent handicapped equipment. There cannot be any changes in the deck elevation around the pool.

All parts of the deck must drain naturally or to floor drains at least 4 feet from the pool and slope between 1% and 2% with no accumulation of water. The space between the coping and the deck must be sealed with an appropriate caulking. A minimum distance of 6 feet between any two pools or spas is required.

For pool enclosures constructed prior to July 1, 1994. The Department may allow the installation of an enclosure which reduces the pool deck to less than 4 feet in width when the physical characteristics of a site preclude providing a 4-foot wide deck around the perimeter of an existing pool.

2. Depth markers are required on the deck at all locations corresponding the wall markers. For pools with a maximum water depth of 6 ft. or less, permanent no diving markers are required next to each of the deck depth markers. All depth markers must be marked with the letters "feet" or "ft." and "inches" or "in". Depth marker letters must be at least 4 inches in height. Painted letters or vinyl decals are **not** permitted.

## Required When the Pool is Drained

1. Depth markers of contrasting color are required on the pool wall at the water line on both sides, at the minimum and maximum depths, at the break in slope, and at both ends of the pool. Waterline depth markers are required to be glazed and easily cleanable waterline tiles. Painted letters or vinyl decals are not permitted. Depth marker numbers must be at least 4 inches in height and must be positioned to indicate the water depth accurate to the nearest 6 inches as measured from the pool floor to the middle of the skimmer opening. Exception; Spa and wading pools require at least 2 depth markers.
2. A ladder as a second means of exit is required at the deep end of a pool having a water depth greater than 4½ ft. Steps and step holds of ladders must have a minimum tread of 5 inches and a minimum width of 14 inches. Step risers must be uniform and not exceed 12 inches. Grab railings must be provided at the top of both sides and extend over the coping or edge of the deck.
3. At least one handrail is required for all stairs. Spas require two handrails. The handrail must be between 28 inches and 36 inches above the deck and above each step tread as measured from the deck and the edge of each step tread to the top of the handrail. The handrail must extend into the pool, from the deck to the bottom step tread, but may not extend beyond the bottom step. A minimum clearance of 3 inches between any handrail and step riser is required. The handrail may not extend onto the deck more than 2 feet or obstruct the deck unnecessarily. (**See Figures and Tables #3 Stair and Handrail Dimensions**).

## Required When the Pool Coping is Replaced

1. Coping on pools must extend out into the pool at least 1 inch but not more than 2 inches. The coping must be at least 1 inch thick but no greater than 2½ inches thick. The handhold of the coping may not be greater than 9 inches above the waterline. All coping or cantilevered decking must be sloped at 1/4 inch per foot away from the pool. Handholds are required around the entire perimeter of the pool. A C-701 type of handhold for rim flow and fiberglass spa pools is required around the entire pool. (**See Figures and Tables #1 Coping for illustrations of the requirements**).

## Required When the Pool is Resurfaced

1. All swimming pools must be lined with white plaster or a smooth, waterproof, white interior finish, impervious to moisture and constructed of reinforced concrete or a material equivalent in strength and durability. If tile is used for the pool shell, a sample of the tile must be submitted for approval. There shall be no letters, images, or markings of any kind other than required safety markings on the pool shell.
2. The pool must be lined with 6" wide waterline tiles around the entire perimeter of the pool. Waterline tiles must be contrasting in color to the white pool shell and be glossy smooth and easily cleanable.
3. In pools greater than 5 ft. in depth, a straight line of slip-resistant tile of contrasting color must be installed where the water depth is 4½ ft. The tile must be at least 4 inches but not greater than 6 inches wide.
4. If a tile edge marker is used along the edge of pool steps, it must be contrasting in color, slip-resistant, and no greater than 4 inches wide.

## Required When the Pool Equipment is Changed, or Pool is Replumbed

1. When changes are being made to the plumbing, most plumbing code requirements are not retroactive. For example, there will not be a requirement to add a skimmer or increase pipe size to conform to current code. However, if the pool is being replumbed, current code flow rate and turnover rates are required. The plans will be reviewed on a case-by-case basis for specific requirements.
2. Pipes are required to be sized so flow velocity of the piping systems including all pipes and fittings, other than inlet devices or venturi throats, do not exceed 6 feet per second (1.829 m/s) in any suction piping and 8 feet per second (2.438 m/s) in any portion of the return system. For pools built prior to September 2012, and that are not undergoing 50% or more change to the plumbing, flow velocity must not exceed 8 feet per second in any suction piping and 10 feet per second in any portion of the return system.
3. Pumps, including variable speed pumps, are required to meet the required turnover rate for the specific pool and not exceed the pipe velocity requirements at the pump's maximum GPM at 60 feet of head.
4. Filters must be sized not to exceed the following:

Diatomaceous Earth	2 GPM/sq.ft.
Rapid Sand	3 GPM/sq.ft.
High Rate Sand	15 - 20 GPM/sq.ft. (See rating in equipment list)
Cartridge	.375 GPM/sq.ft.
5. A vacuum gauge placed before the pump is required anytime a recirculation pump is replaced.
6. If the chlorinator is altered or replaced, an automatic chlorinator is required which is capable of supplying not less than the equivalent of 3 pounds of chlorine per day per 10,000 gallons of pool water capacity. For pools constructed prior to September 2012, chlorinators sized to at least 2 lbs. per 10,000 gallons per day are required.

## Required When the Pool Enclosure is Altered or Replaced

1. The pool is required to be enclosed by one or a combination of the following: a fence; portion of a building; wall; or other approved durable enclosure. Doors, openable windows, gates of living units or associated private premises are not permitted as part of the pool enclosure. The enclosure is required to meet all of the following specifications if built on or after July 1, 1994. If built before July 1, 1994, it must at least have a 4-foot enclosure fence and a self-closing and self-latching gate, including existing courtyard pools. **(See Figures and Tables #2)**
  - a. The enclosure is required to have a minimum effective perpendicular height of 5 feet as measured from the outside.

- b. Openings, holes or gaps in the enclosure, doors and/or gates may not allow the passage of a 4-inch diameter sphere. The enclosure is required to be constructed over a hard and permanent material equivalent to concrete.
  - c. The enclosure is required to be designed and constructed so that it cannot be readily climbed by small children. Horizontal and diagonal member designs which might serve as a ladder for small children are prohibited. Horizontal members are required to be spaced at least 48 inches apart. No planters or other structures that can be climbed upon will be permitted within 5 feet of the outside of the pool enclosure or within a 5-foot arc. The area 5 feet outside of the pool enclosure is required to be a common area open to the public.
  - d. Chain link may be used provided that the openings are not greater than 1¾ inches measured horizontally.
  - e. The 5-foot areas outside the enclosure must be public areas, open to all patrons of the pool.
  - f. A 5-foot clear radius is required outside of the fence enclosure with no trees, lamp posts, or any object that can be climbed.
  - g. The enclosure cannot adjoin a private property. A 5-foot clearance is required from adjacent properties.
  - h. The deck and ancillary facilities are required to be designed and intended to be used by pool users as defined as those engaged in water activity such as diving, swimming, or wading, or watching those engaged in water activity. Pool user amenities such as a barbeques and fire pits are allowed within view of the pool and in a manner that does not encroach on required deck space, if similar amenities are provided outside the pool enclosure for non-pool users.
2. Gates and doors of the pool enclosure are required to meet the following specifications. The enclosure is required to meet all of the following specifications if built on or after July 1, 1994. If built before July 1, 1994, it must at least have a 4-foot enclosure fence and a self-closing and self-latching gate, including existing courtyard pools. **(See Figures and Tables #2)**
- a. Gates and doors are required to be equipped with self-closing and self-latching devices. The self-latching devices are required to keep the gate or door securely closed. Gates and doors are required to open outwardly away from the pool except where otherwise prohibited by law. Hand activated door or gate opening hardware are required to be located at a height no lower than 42 inches but no higher than 44 inches above the deck or walkway.
  - b. Gates and doors are required to be capable of being locked during times when the pool is closed. Exit doors which comply with Chapter 10, Title 24, California Code of Regulations shall be considered as meeting these requirements.
  - c. The pool enclosure is required to have at least one means of egress without a key for emergency purposes. Unless all gates or doors are so equipped, those gates and/or doors which will allow egress without a key are required to have a sign in letters at least 4 inches high stating EMERGENCY EXIT.
  - d. The enclosure is required to be constructed so that all persons will be required to pass through common pool enclosure gates or doors in order to gain access to the pool area. All gates and doors exiting the pool area are required to open into a walkway or public area accessible by all patrons of the pool. (Except pre-existing courtyard pools built prior to July 1, 1994).

### Required When Restrooms are Added or Changed

- 1. Separate men's and women's public toilet facilities are required at the pool, except when living quarters of the farthest pool user is less than 300 feet travel distance from the pool. The distance is the walking distance from the pool wall to the furthest unit and includes 10 feet for each floor of multi-story buildings.

If two pools are located on the same property and all living units are within 300 feet walking distance to either pool, no toilet facilities are required. If restroom and shower facilities are not required, but provided, the facilities need not comply with the swimming pool code regarding separate men's and women's facilities, urinals, and floor drains, but must be constructed so as to be readily cleanable and comply with Building and Safety Department requirements.

Urinal(s) are required in the men's restroom and in unisex restrooms. When restrooms and shower facilities are required, they must be at the pool or adjacent to the pool area and located not more than 100 feet walking distance away and be easily accessible by pool users.

2. For calculating the number of showers, toilets, urinals, lavatories, and drinking fountains, one pool user is considered for every 15 square feet of pool surface area. Add multiple pools in the same area together.
  - a. One shower with hot and cold water must be provided for every 50 pool users.
  - b. One lavatory with hot and cold water must be provided for every 80 pool users.
  - c. One toilet must be provided for every 60 women and one toilet and one urinal for every 75 men.
  - d. One guarded jet drinking fountain must be provided for the first 250 pool users and an additional fountain must be provided for each additional 200 pool users or fraction thereof.

### Required When Solar Power is Added or Changed

1. Solar panels and all components must meet National Sanitation Foundation (NSF) Standard 50.
2. Split suction outlets are required to be located at the deepest section of the pool so that covers are at the bottom of the pool or within 3 inches of the pool floor and no closer than 5 feet from any inlet.
3. Pipe velocity and sizing requirements must be met.

## CONSTRUCTION INSPECTIONS

The contractor is required to contact the Recreational Waters Program to make an appointment (5 days prior) and obtain approval for the following inspections;

1. **Plumbing** (Pre-Gunite): Exposed plumbing and prior to applying gunite or applying pneumatically placed concrete (If applicable).
2. **Pre-Plaster**: Prior to plastering or applying the final surface to the pool shell (If applicable).
3. **Final**: At the completion of the change or remodel. Written approval from the Recreational Waters Program is required to open the pool to the public.

For further information, visit our web site at:

<http://www.publichealth.lacounty.gov/eh/inspection/pool-plan-check.htm>

1. Coping

APPROVED COPING

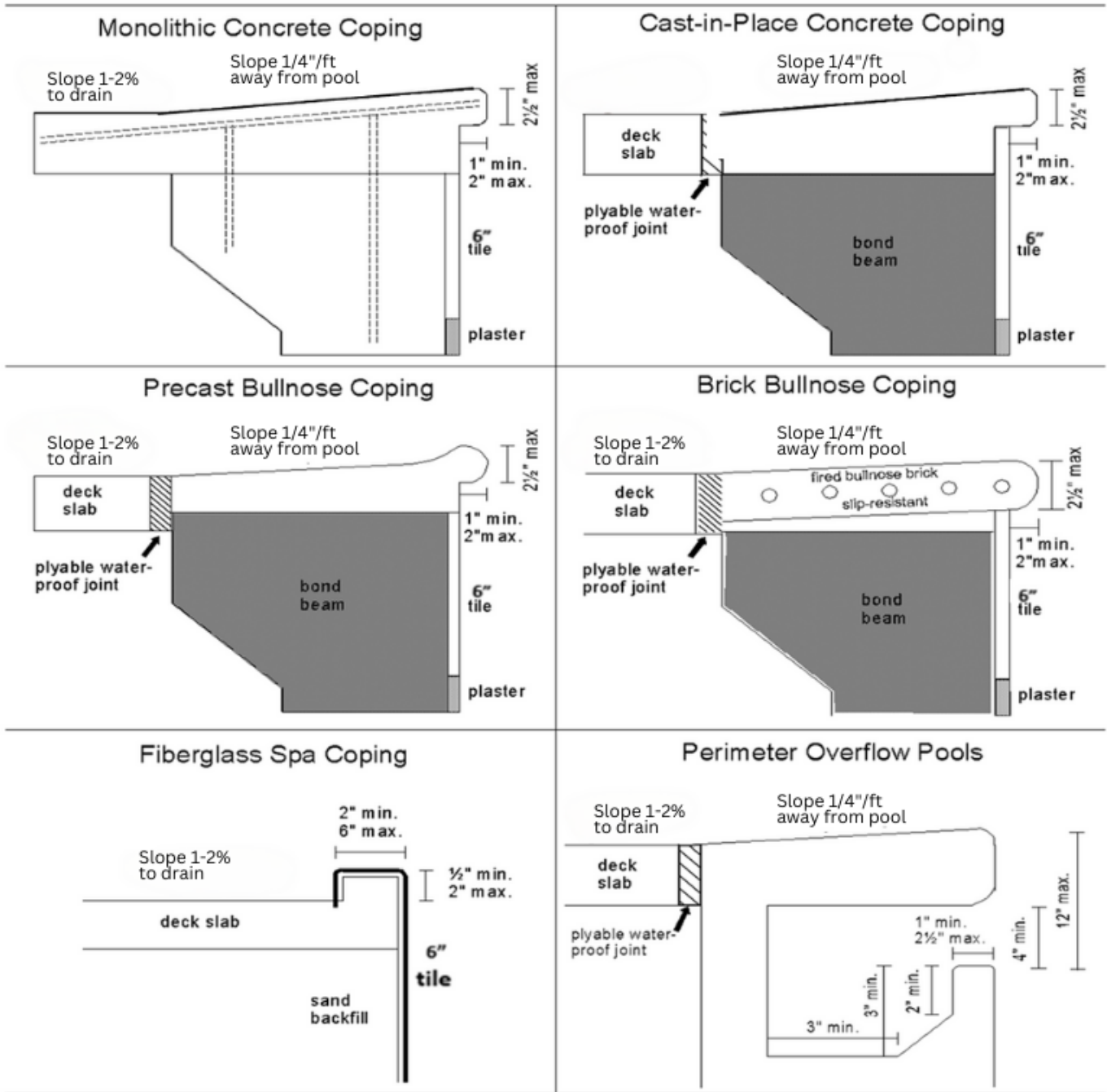

Rim Flow Pools (C701 type)

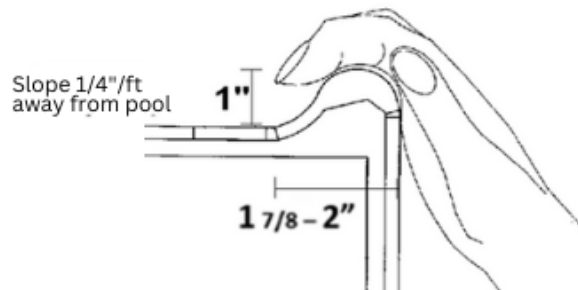



## 2. Fencing Dimensions

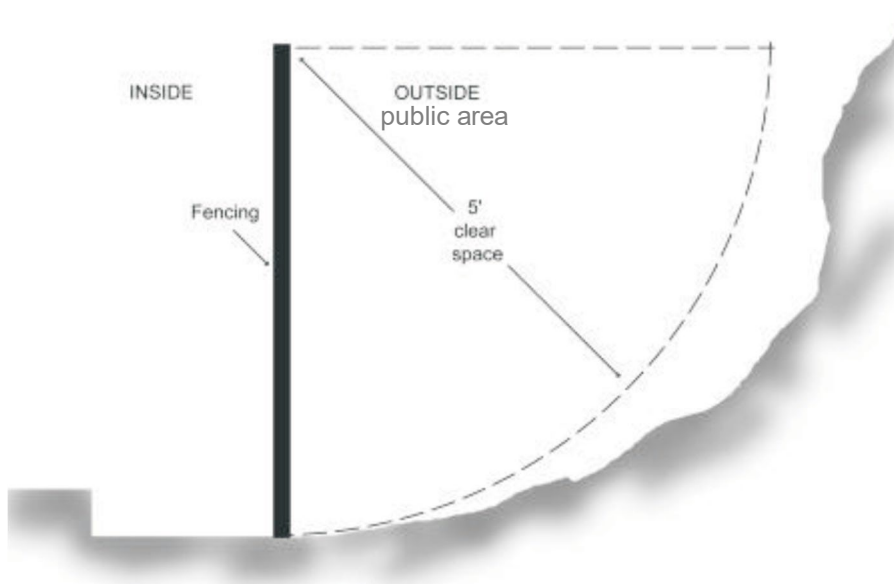
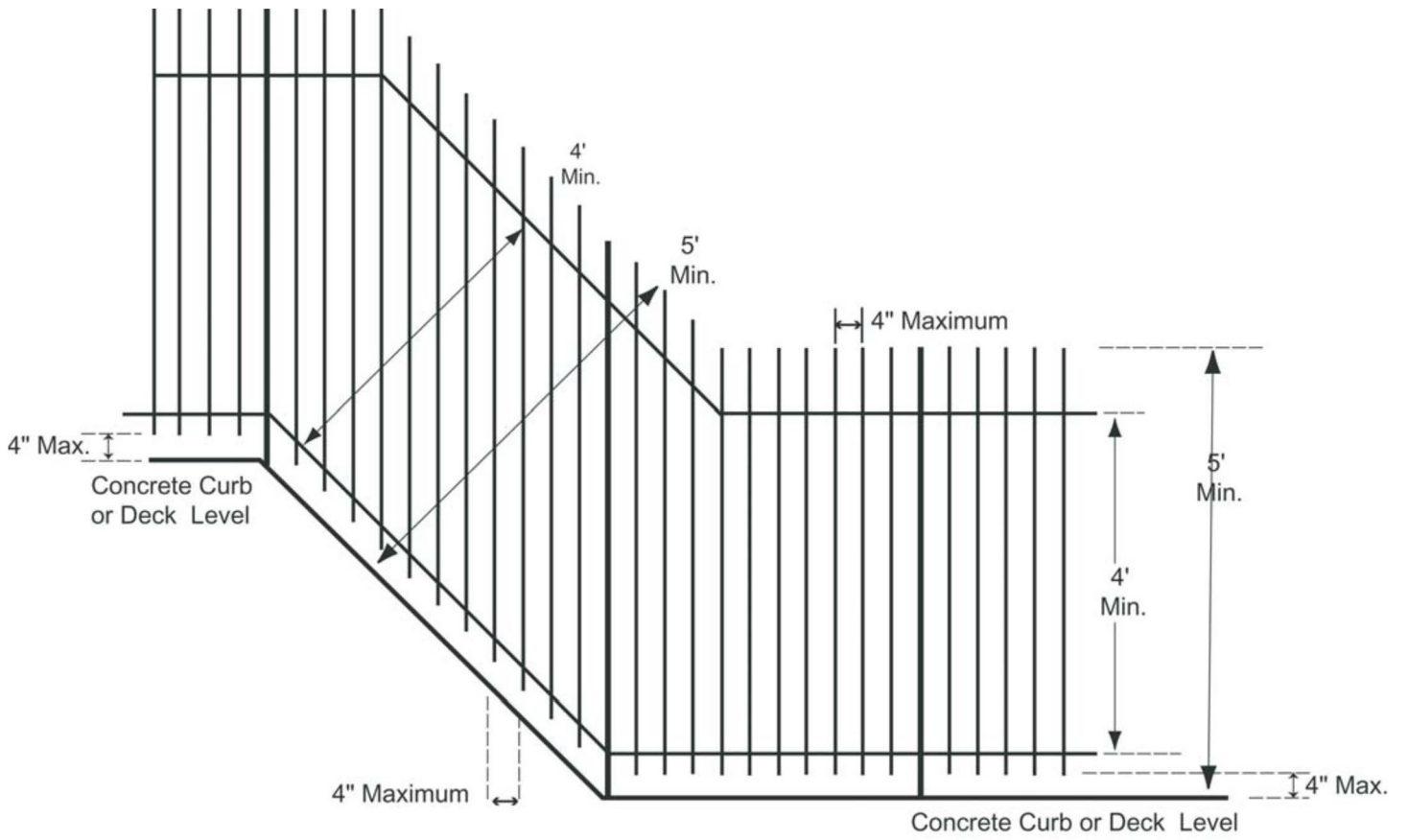

### 3. Stair and Handrail Dimensions

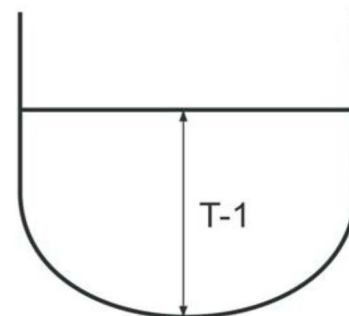
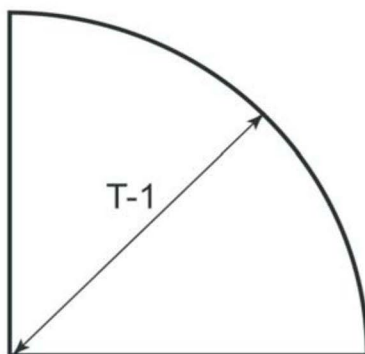
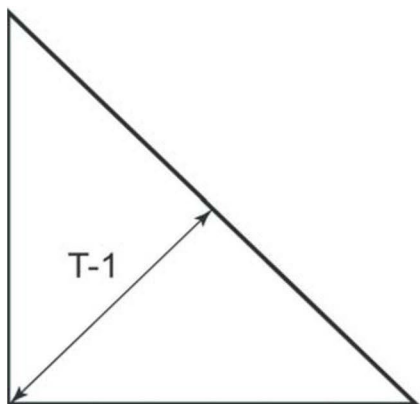
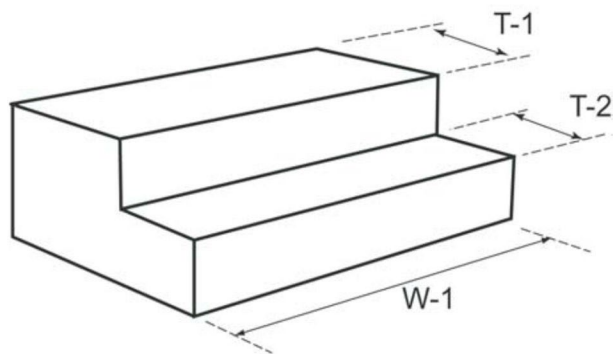
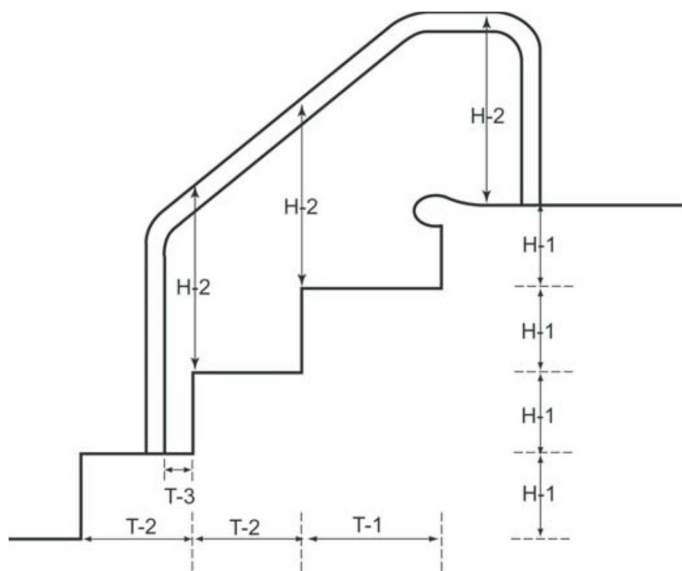

Dimensions	T-1 Standard	T-1 Triangular, Concave, Convex	T-2	T-3	W-1	H-1	H-2
Minimum	14"	21"	12"	3"	24"	6"	28"
Maximum	18"	24"	16"	---	---	12"	36"

## APPENDICES – Checklist

### Required Items for Public Pool Renovation Plan Check Submission

For your use and to be verified when submitting plans

Included (Check)	Required Item	Comment
	Complete Application (for each pool)	
	Fee	
	2 Sets of Drawings	
	Top View of Pool	
	Plumbing Diagram as Applicable	
	Plot Plan if Applicable	
	Highlighted Pool Enclosure Boundary if Applicable	
	Equipment Room if Applicable	
	Deck Details if Applicable	
	Pool Enclosure Details if Applicable	
	Restroom Details if Applicable	
	Solar Heating System Details if Applicable	
	General Data and Equipment List	
	Other	

